

## JUMEM 40L



CF - Justierstücke DN 40 CF		Flansche 1.4306		Flansche 1.4429 ESU	
Basisflansch	Topflansch	Artikel	€/Stck	Artikel	€/Stck
Gewindebohrungen	Durchgangsbohrungen	<b>JUMEM 40K</b>	465,-	<b>JUMEM 40K-29</b>	498,-
Durchgangsbohrungen	Durchgangsbohrungen	<b>JUMEM 40M</b>	470,-	<b>JUMEM 40M-29</b>	503,-
Durchgangsbohrungen	Durchgangsbohrungen	<b>JUMEM 40L</b>	505,-	<b>JUMEM 40L-29</b>	545,-

☒ Balg und Rohre 1.4404

### JUMEM 40K

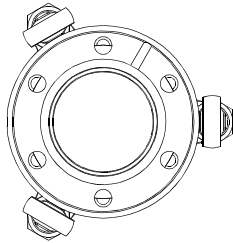
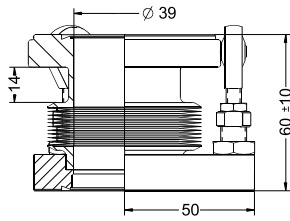

### JUMEM 40M

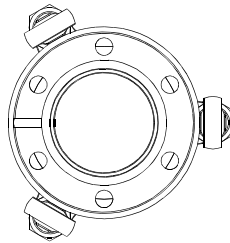
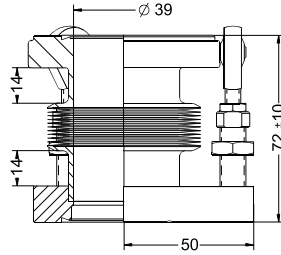

### JUMEM 40L

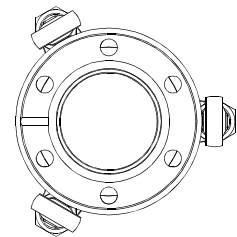
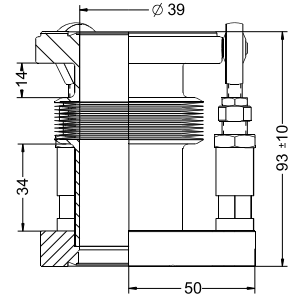

## JUMEM 63K



CF - Justierstücke DN 63 CF		Flansche 1.4306		Flansche 1.4429 ESU	
Basisflansch	Topflansch	Artikel	€/Stck	Artikel	€/Stck
Gewindebohrungen	Durchgangsbohrungen	<b>JUMEM 63K</b>	598,-	<b>JUMEM 63K-29</b>	695,-
Durchgangsbohrungen	Durchgangsbohrungen	<b>JUMEM 63M</b>	618,-	<b>JUMEM 63M-29</b>	730,-
Durchgangsbohrungen	Durchgangsbohrungen	<b>JUMEM 63L</b>	668,-	<b>JUMEM 63L-29</b>	765,-

☒ Balg und Rohre 1.4404

### JUMEM 63K

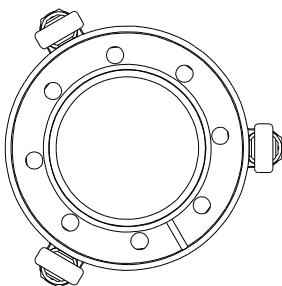
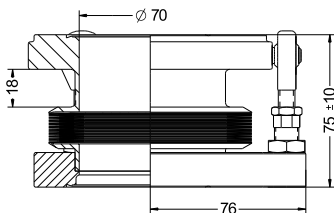

### JUMEM 63M

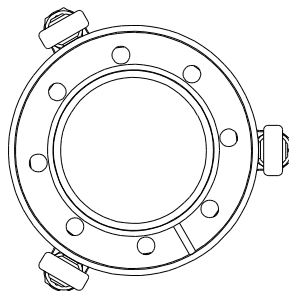
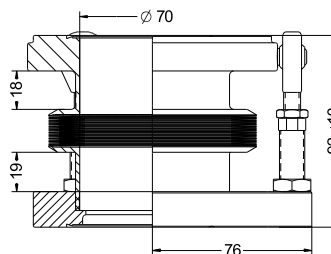

### JUMEM 63L

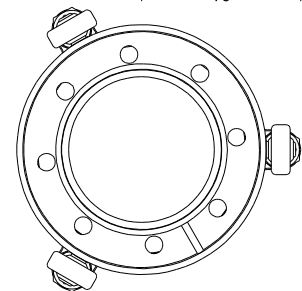
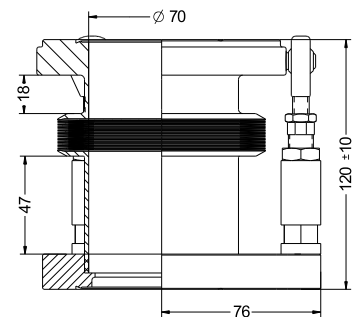

## JUMEM 100L



CF - Justierstücke DN 100 CF		Flansche 1.4306		Flansche 1.4429 ESU	
Basisflansch	Topflansch	Artikel	€/Stck	Artikel	€/Stck
Gewindebohrungen	Durchgangsbohrungen	<b>JUMEM 100K</b>	780,-	<b>JUMEM 100K-29</b>	990,-
Durchgangsbohrungen	Durchgangsbohrungen	<b>JUMEM 100M</b>	795,-	<b>JUMEM 100M-29</b>	1.005,-
Durchgangsbohrungen	Durchgangsbohrungen	<b>JUMEM 100L</b>	820,-	<b>JUMEM 100L-29</b>	1.025,-

☒ Balg und Rohre 1.4404

### JUMEM 100K

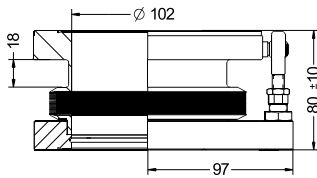

### JUMEM 100M

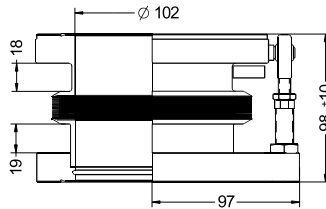

### JUMEM 100L

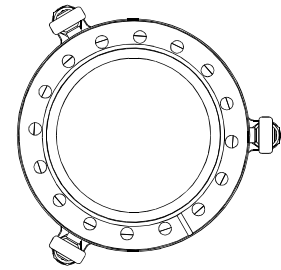
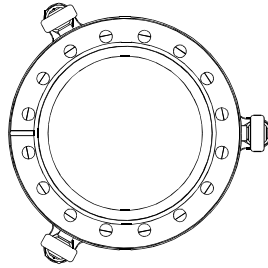
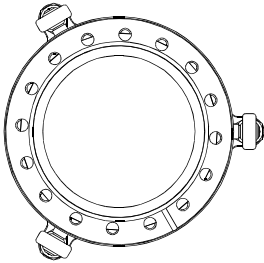
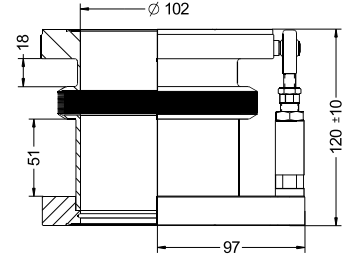

## JUMEM 160L



CF - Justierstücke DN 160 CF		Flansche 1.4306		Flansche 1.4429 ESU	
Basisflansch	Topflansch	Artikel	€/Stck	Artikel	€/Stck
Gewindebohrungen	Durchgangsbohrungen	<b>JUMEM 160K</b>	1.110,-	<b>JUMEM 160K-29</b>	1.330,-
Durchgangsbohrungen	Durchgangsbohrungen	<b>JUMEM 160M</b>	1.130,-	<b>JUMEM 160M-29</b>	1.350,-
Durchgangsbohrungen	Durchgangsbohrungen	<b>JUMEM 160L</b>	1.165,-	<b>JUMEM 160L-29</b>	1.385,-

☒ Balg und Rohre 1.4404

### JUMEM 160K

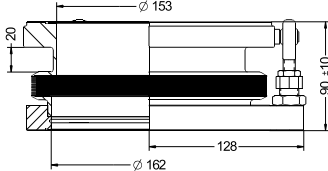

### JUMEM 160M

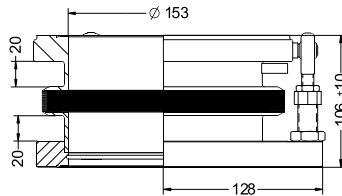

### JUMEM 160L

